

MORSA MODULARE MULTIPLA HRV-1

MULTIPLE MODULAR VISE HRV-1

Questo tipo di morsa modulare multipla è stata ideata per poter bloccare contemporaneamente più pezzi di varie dimensioni e forma (tondi, rettangolari, sagome irregolari). Accresce la capacità di lavoro della macchina e per la sua semplicità e versatilità nell'uso, riduce i tempi morti necessari per l'attrezzamento di ogni lavorazione, con la conseguente riduzione dei costi.

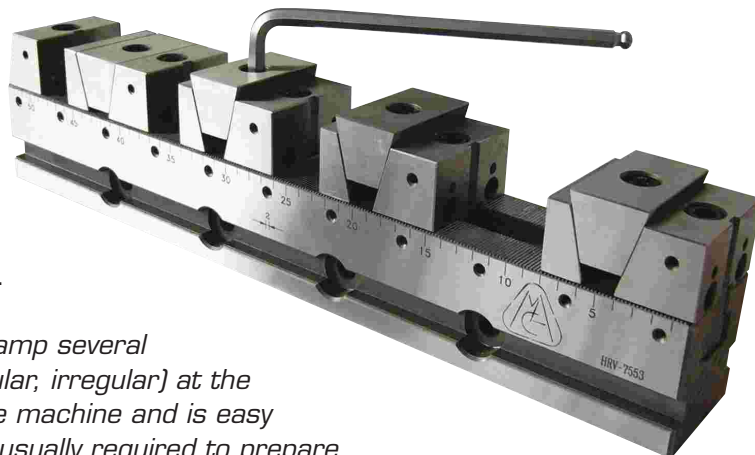

This type of multiple modular vise is designed to clamp several pieces of different size and shape (round, rectangular, irregular) at the same time. It increases the working capacity of the machine and is easy to use and flexible, thus reducing the down times usually required to prepare for different manufacturing session and therefore contributes to reducing costs.

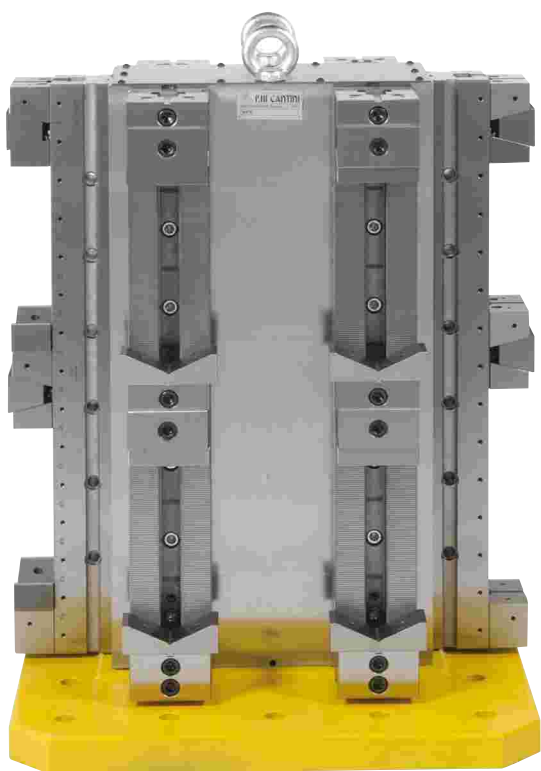

Esempio di serraggio Clamping examples

Serraggio di pezzi cilindrici
Serraggio di pezzi di varie forme
Serraggio di pezzi piccoli rettangolari

*Clamping of cylindrical pieces
Clamping of pieces with different shapes
Clamping of several small rectangular*

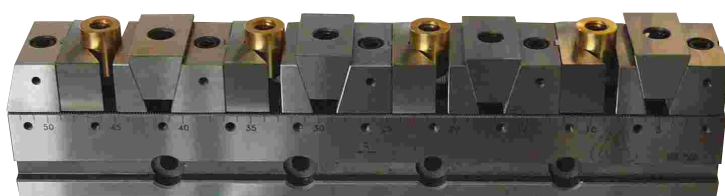
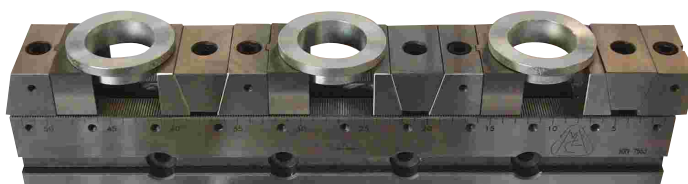
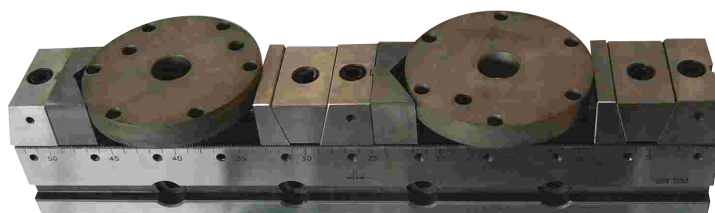

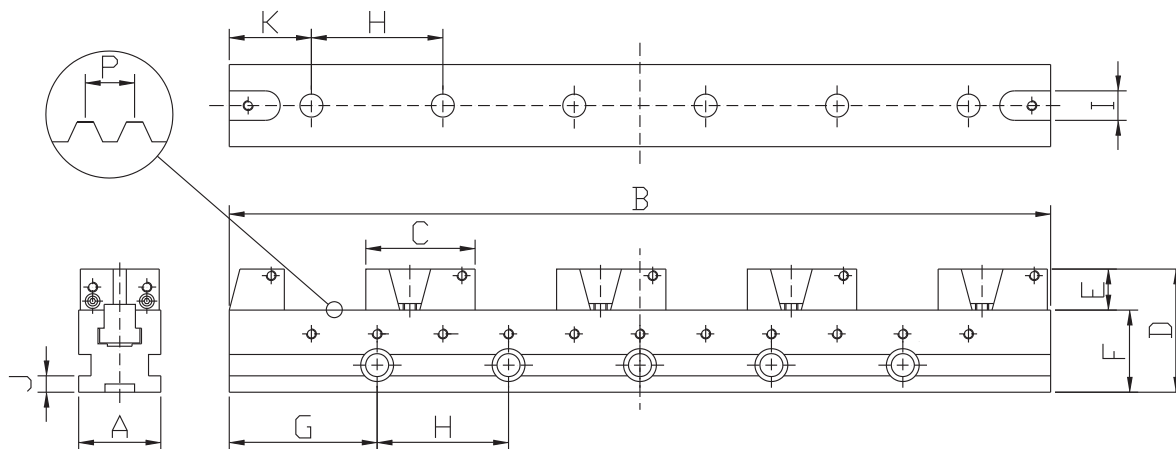

	A	B	C	D	E	F	G	H	I	J	K	P	Kg.
HRV-I 5030	50	300	66	75	25	50	70	80	18	10	30	1,5	7
HRV-I 5040		400					80				40		9
HRV-I 5050		500					90				50		10
HRV-I 5060		600					60				60		11
HRV-I 5070		700					110				70		12
HRV-I 7543	75	430	85	115	40	75	115	100	18	17	65	2	20
HRV-I 7553		530					115						25.5
HRV-I 7563		630					115						29.5
HRV-I 7573		730					65						33.5
HRV-I 10055	100	550	108	125	50	75	75	100	18	17	125	2,5	39.5
HRV-I 10065		650					125				75		44
HRV-I 10075		750					125				75		49

Materiale: Acciaio cementato HCR55
Material: HCR55 Cemented steel

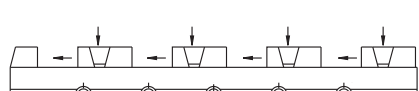
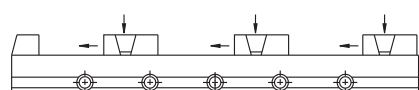
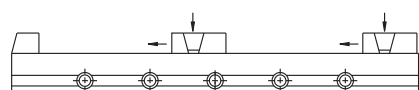
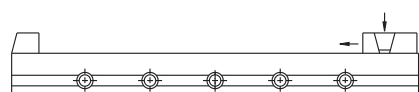

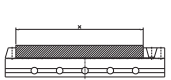
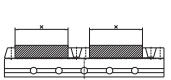
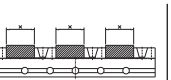
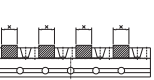
				
HRV-I 5030	199	66	22	-
HRV-I 5040	299	116	55	25
HRV-I 5050	399	166	89	50
HRV-I 5060	499	216	122	75
HRV-I 5070	599	266	155	100
HRV-I 7543	300	109	44	-
HRV-I 7553	400	159	77	49
HRV-I 7563	500	209	111	62
HRV-I 7573	600	259	144	87
HRV-I 10055	390	142	58	-
HRV-I 10065	490	192	92	42
HRV-I 10075	590	242	125	67

L'apertura "X" della morsa è in funzione del numero delle ganasce che sono montate sulla slitta.
 The "X" opening of the vise depends on the number of jaws mounted on the slide

COMPONENTI
COMPONENTS

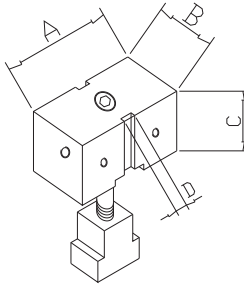
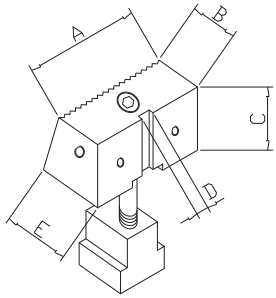
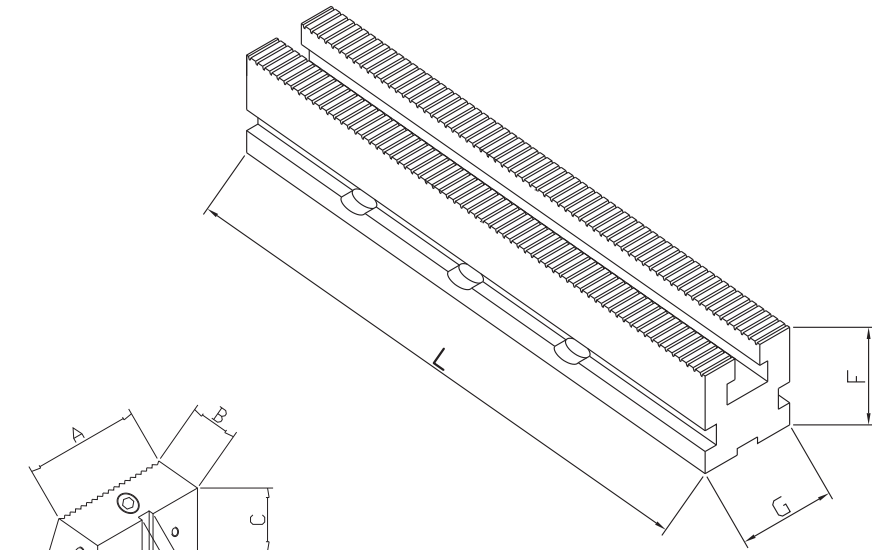

	A	B	C	D
HRV-I 50B	48	35	25	8
HRV-I 75B	73	42	40	8
HRV-I 100B	98	55	50	8

	G	F	L
HRV-I 50A30	50	50	300
HRV-I 50A40			400
HRV-I 50A50			500
HRV-I 50A60			600
HRV-I 50A70			700
HRV-I 75A43	75	75	430
HRV-I 75A53			530
HRV-I 75A63			630
HRV-I 75A73			730
HRV-I 100A55	100	75	550
HRV-I 100A65			650
HRV-I 100A75			750

	A	B	C
HRV-I 50C	48	27	25
HRV-I 75C	73	30	40
HRV-I 100C	98	35	50